

PENDANT LIGHT INSTRUCTION MANUAL

Product : ILCP153

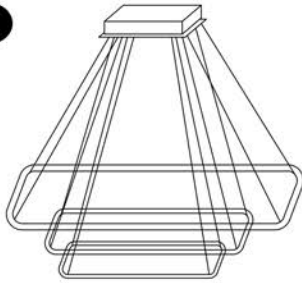

PACKING INCLUDED



Wire nuts x 3

Hex nuts x 2

SAFETY INSTRUCTIONS

- The manufacturer advises the correct use of lighting fittings! Therefore always follow these instructions to ensure correct and safe installation and functioning of the fitting and keep it for future reference.
- Always isolate the power before commencing installation, maintenance or repair.
- If in doubt, consult a qualified electrician or contact your retail outlet, Ensure that you always install the fitting to the relevant regulations. Certain regulations indicate that lighting fittings should be installed by a qualified electrician.
- Always tighten the terminal screws firmly.
- Observe the correct colour of the wiring before installation: White (N), Black (L) and if protection class I, yellow/green (earth)
- Maintain interior lighting with a dry cloth duster, do not use abrasives or solvents. Avoid liquid on all electrical parts.
- Please mount wall lights out of children's reach.
- If the luminaire is mounted on a metallic surface, this surface must be bonded to the protective earth conductor or to the equipotential bonding conductor of the installation.
- Always consider all the technical specifications of the fitting.

ATTENTION

- This fitting should only be installed indoors.
- The fitting is suitable for fixing to normal flammable surfaces.
- Protection class I: the fitting has an earthing connection, The earth wire (yellow/green) has to be connected, too.

WARRANTY

- In case of construction faults or material damages the manufacturer gives a guarantee up to 2 years for indoor lighting.
- Broken glass, batteries and lighting bulbs do not fall under the guarantee terms. Any damage caused to the light fitting in extreme conditions (coastal areas, industrial surroundings, farm environments) will not be covered by the guarantee.
- The period of guarantee starts from the purchase date and is only valid on presentation of the receipt.
- The guarantee is void if the fitting was not installed following the instructions or repaired or modified. The manufacturer does not accept any liability for damage caused as a result of misuse or wrong application of the fitting.
- Alterations in design and technical specifications reserved.

INSTALLATION

Before installation, must cut off the power!

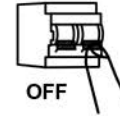

1

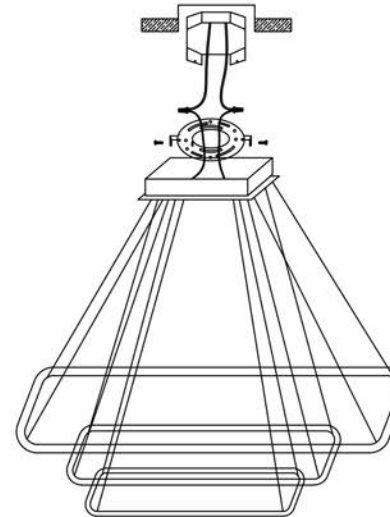

2

Turn on the light and enjoy

