

Product: Pole/Street Light
Model Number(s): MLPLXW



Product

Meomi Lighting energy saving high quality pole/street light. Made with high efficiency LED chips and high quality materials for all your project needs. Our pole/street lights are offered with industry leading warranty package.

LED Details

Luminous Efficacy: 100/140 Lumens/Watt
CRI \geq 70 or 80
Colour Offerings: 3000-6000 K
Life: 50,000 Hours

Electrical

Voltage:100-277 VAC/347 VAC as well
Power: 100/150/200/250 & 300 Watt Offerings
Power Factor \geq .90
Photocell: Optional
Dimmable: Yes, Optional

Materials

Extruded aluminium black housing
Aluminium heat sink directly attached
4 different mounting designs
Clear glass covering
Anti-Static powder painting



Warranty

60 months from shipment

Certification



Design Options

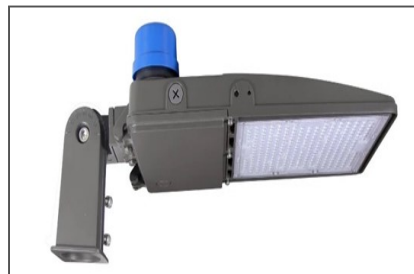

Dimensional Drawings (Dimensions in mm)

100 Watt Pole Lights

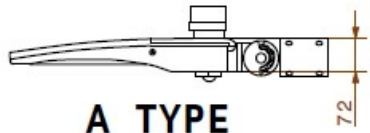
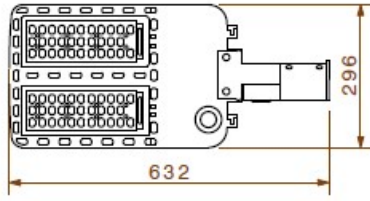

A TYPE

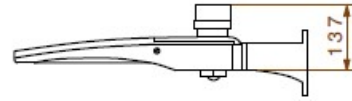
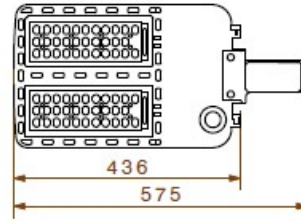

B TYPE

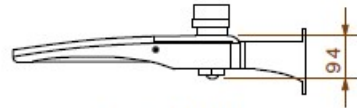
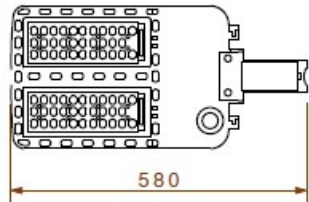

C TYPE

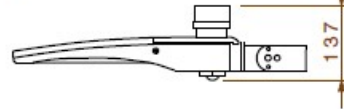
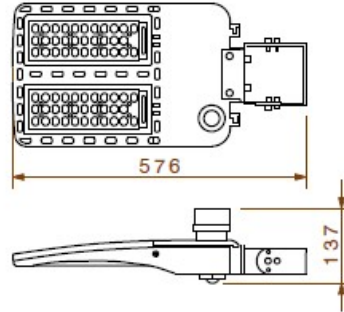

D TYPE

ALL DIMENSIONS IN mm

Technical Specification

Power (Watt)	Input Voltage (V)	Luminous Efficacy (Lm/Watt)	Lumen Output (Lumens)	Typical CCT (K)	CRI
100	100-277 V AC Or 347 V AC	100	10,000	3000-6000	70 Or 80
150			15,000		
200			20,000		
250			25,000		
300			30,000		
100			140		
150	21,000				
200	28,000				
250	35,000				
300	42,000				

Photometric View

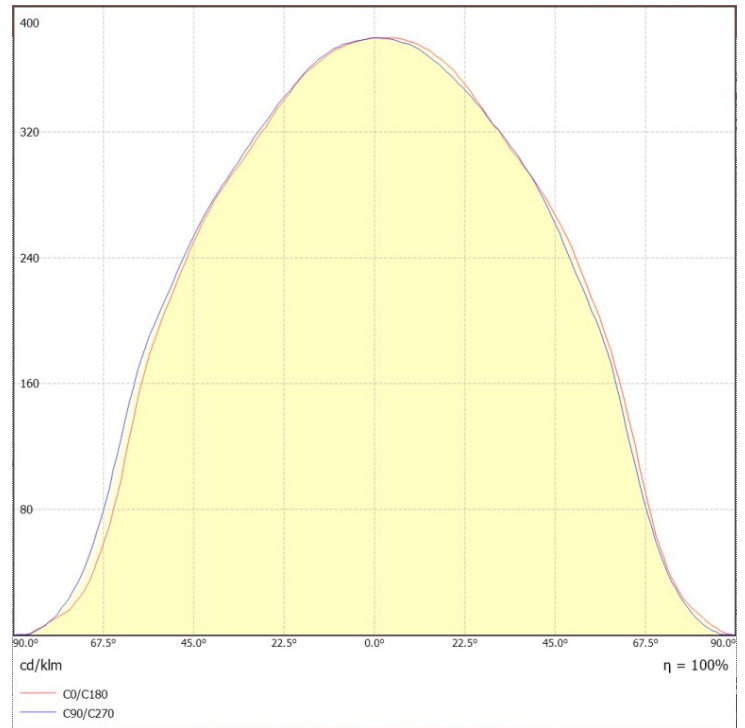
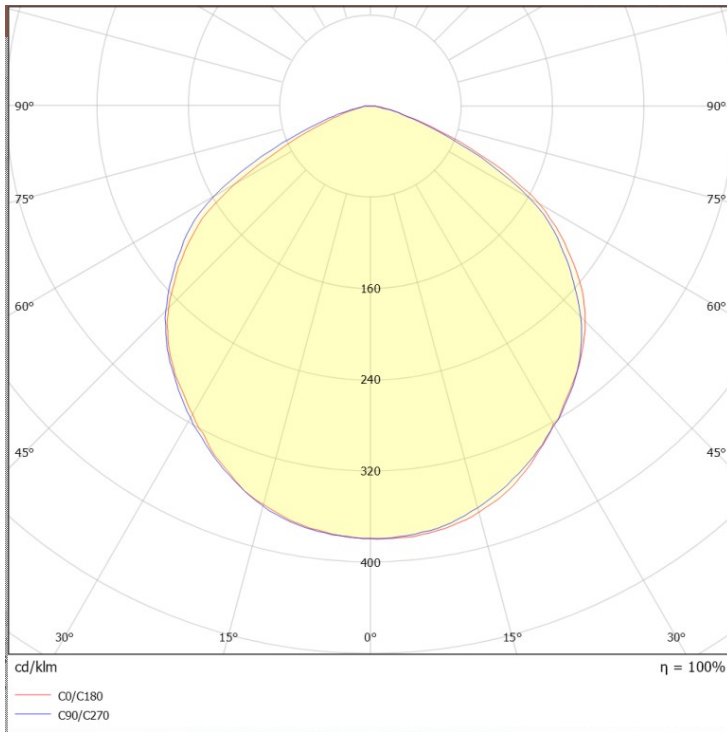

Please note the following:

- * Product details are subject to change without prior notice
- * Please contact nearest Meomi Lighting team/representative for all engineered solutions requirements
- * Products may vary from the picture(s) provided in this data sheet

Meomi Lighting Inc.
300-22 King Street South
Waterloo, ON
Tel: 226.499.8547
Fax: 519.279.0162

Email: reachout@meomilighting.com
www.meomilighting.com